

Datasheet - AZ 16-12ZVRK

Safety switch with separate actuator / AZ 16



Preferred typ



(Minor differences between the printed image and the original product may exist!)

- Thermoplastic enclosure
- Double-insulated
- Large wiring compartment
- 52 mm x 90 mm x 30 mm
- Multiple coding
- Long life
- High level of contact reliability with low voltages and currents
- Insensitive to soiling
- Slotted holes for adjustment, circular holes for location
- 3 cable entries M 16 x 1.5

Ordering details

Product type description	AZ 16-12ZVRK
Article number	101154221
EAN code	4030661171586
eCl@ss	27-27-26-02

Approval

Approval

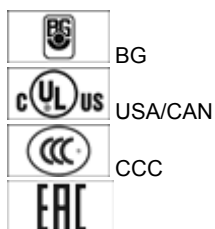

Classification

Standards	EN ISO 13849-1
B _{10d} Opener (NC)	2.000.000
B _{10d} Normally open contact (NO)	1.000.000
- notice	at 10% I _e and ohmic load
Mission time	20 Years
notice	

$$MTTF_d = \frac{B_{10d}}{0,1 \times n_{op}}$$

$$n_{op} = \frac{d_{op} \times h_{op} \times 3600 \text{ s/h}}{t_{cycle}}$$

Global Properties

Product name	AZ 16
Standards	EN 60947-5-1, BG-GS-ET-15
Compliance with the Directives (Y/N) 	Yes
Materials	
- Material of the housings	Plastic, glass-fibre reinforced thermoplastic, self-extinguishing
- Material of the contacts	Silver
Housing coating	None
Weight	120 g

Mechanical data

Design of electrical connection	Screw connection
Cable section	
- Min. Cable section	0,75 mm ²
- Max. Cable section	2.5 mm ²
Mechanical life	> 1.000.000 operations
notice	All indications about the cable section are including the conductor ferrules.
higher Latching force (Y/N)	Yes
Latching force	30 N
With ejection force (Y/N)	No
Positive break force	20 N
positive break travel	8 mm
Actuating speed	max. 2 m/s

Ambient conditions

Ambient temperature	
- Min. environmental temperature	-30 °C
- Max. environmental temperature	+80 °C
Protection class	IP67 to IEC/EN 60529

Electrical data

Design of control element	Normally open contact (NO), Opener (NC)
Switching principle	Creep circuit element
Number of auxiliary contacts	1 piece
Number of safety contacts	2 piece
Rated impulse withstand voltage U_{imp}	6 kV
Rated insulation voltage U_i	500 V
Thermal test current I_{the}	10 A
Utilisation category	AC-15: 230 V / 4 A, DC-13: 24 V / 4 A
Max. fuse rating	6 A gG D-fuse

ATEX

Explosion protection categories for gases	None
Explosion protected category for dusts	None

Dimensions

Dimensions of the sensor

- Width of sensor	52 mm
- Height of sensor	90 mm
- Length of sensor	30 mm

Included in delivery

Actuators must be ordered separately.

Diagram

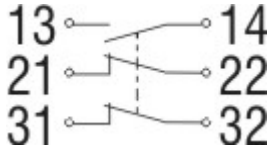

Note Diagram

- positive break NC contact
- active
- no active
- Normally-open contact
- Normally-closed contact

Switch travel diagram

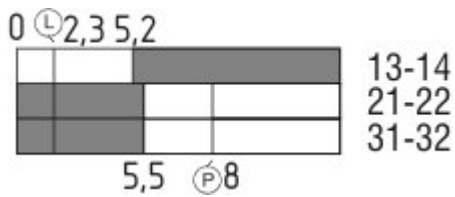

Notes Switch travel diagram

- Contact closed
- Contact open
- Setting range
- Break point
- Positive opening sequence/- angle
- VS** adjustable range of NO contact
- VÖ** adjustable range of NC contact
- N** after travel

Ordering suffix

The applicable ordering suffix is added at the end of the part number of the safety switch.

Order example: AZ 16-12ZVRK-2254

...-2254 Latching force 5 N

...-M20 cable entries M20

Ordering code

AZ 16-(1)ZV(2)K-(3)-(4)-(5)

(1)	
<i>without</i>	1 Normally open contact (NO) / 1 Opener (NC)
02	2 Opener (NC)
03	3 Opener (NC)
12	Normally open contact (NO) 1 / Opener (NC) 2
(2)	
<i>without</i>	Ejection force
R	Latching force 30 N
(3)	
G24	with LED (<i>only available for version with one NO and one NC contact.</i>)
(4)	
<i>without</i>	Cable entry M16
M20	Cable entry M20
ST	Connector M12, 4-pole, bottom
STL	Connector M12, 4-pole, left
STR	Connector M12, 4-pole, right
(5)	
2254	Latching force 5 N
1762	Front mounting
1637	gold-plated contacts

Documents

Operating instructions and Declaration of conformity (pt) 433 kB, 25.05.2010

Code: mrl_az15-16_pt

Operating instructions and Declaration of conformity (pt) 268 kB, 21.08.2013

Code: mrl_az15-16_pt

Operating instructions and Declaration of conformity (de) 265 kB, 05.10.2015

Code: mrl_az15-16_de

Operating instructions and Declaration of conformity (fr) 268 kB, 29.07.2013

Code: mrl_az15-16_fr

Operating instructions and Declaration of conformity (jp) 374 kB, 10.07.2013

Code: mrl_az15-16_jp

Operating instructions and Declaration of conformity (cs) 400 kB, 11.10.2011

Code: mrl_az15-16_cs

Operating instructions and Declaration of conformity (es) 282 kB, 24.11.2015

Code: mrl_az15-16_es

Operating instructions and Declaration of conformity (pl) 313 kB, 06.02.2015

Code: mrl_az15-16_pl

Operating instructions and Declaration of conformity (sv) 275 kB, 17.06.2015

Code: mrl_az15-16_sv

Operating instructions and Declaration of conformity (da) 398 kB, 17.11.2011

Code: mrl_az15-16_da

Operating instructions and Declaration of conformity (en) 280 kB, 05.10.2015

Code: mrl_az15-16_en

Operating instructions and Declaration of conformity (ro) 400 kB, 18.11.2011

Code: mrl_az15-16_ro

Operating instructions and Declaration of conformity (nl) 266 kB, 02.07.2013

Code: mrl_az15-16_nl

Operating instructions and Declaration of conformity (fi) 256 kB, 02.07.2015

Code: mrl_az15-16_fi

Operating instructions and Declaration of conformity (it) 276 kB, 04.11.2015

Code: mrl_az15-16_it

Mounting and wiring instructions (de, en, fr, it, es, jp) 181 kB, 12.06.2007

Code: m_mazp01

BG-test certificate (en) 135 kB, 18.11.2014

Code: z_z15p02

BG-test certificate (de) 138 kB, 18.11.2014

Code: z_z15p01

CCC certification (cn) 270 kB, 20.01.2016

Code: q_175p03

CCC certification (en) 316 kB, 20.01.2016

Code: q_175p02

EAC certification (ru) 844 kB, 05.10.2015

Code: q_6037p17_ru

Images

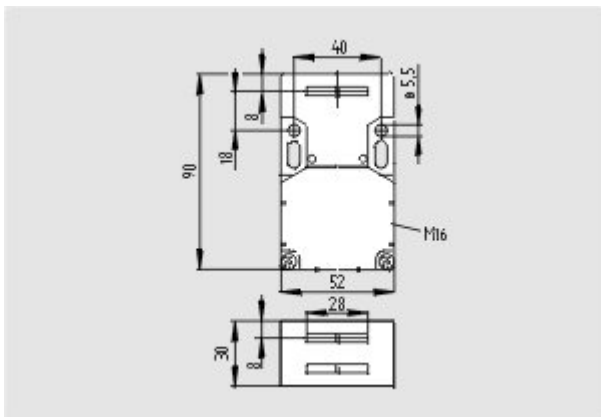

Dimensional drawing (basic component)

System components

Actuator

101083036 - AZ 15/16-B1



101092711 - AZ 15/16-B1-1747

- For play-free interlocking of light guards
- Suitable for retrofitting



101093553 - AZ 15/16-B1-1747

- For play-free interlocking of light guards
- The magnetic latch can be easily fitted in any actuating plane
- Suitable for retrofitting



101108276 - AZ 15/16-B1-2024



101108278 - AZ 15/16-B1-2024 WITH SLOT SEALING PLUG

- For protection against the ingress of course dirt



101111079 - AZ 15/16-B1-2053

- For interlocking of light to medium-weight guards



101111081 - AZ 15/16-B1-2053 WITH BALL LATCH

- For interlocking of light to medium-weight guards



101126793 - AZ 15/16-B1-2177

- For interlocking of light, unguided guards





101126794 - AZ 15/16-B1-2177 WITH CENTERING GUIDE

- For interlocking of light, unguided guards



101137408 - AZ 15/16-B1-2245

- Damps vibration on guard device



101095558 - AZ 15/16-B2

- For very small actuating radii in line with the plane of the actuator



101096091 - AZ 15/16-B2-1747

- For very small actuating radii in line with the plane of the actuator
- Suitable for retrofitting
- For play-free interlocking of light guards



101096089 - AZ 15/16-B2-1747 WITH MAGNETIC LATCH

- For very small actuating radii in line with the plane of the actuator
- Suitable for retrofitting
- For play-free interlocking of light guards
- The magnetic latch can be easily fitted in any actuating plane



101095550 - AZ 15/16-B3

- For very small actuating radii at 90° to the plane of the actuator



101096090 - AZ 15/16-B3-1747 WITH MAGNETIC LATCH

- For very small actuating radii at 90° to the plane of the actuator
- Suitable for retrofitting
- For play-free interlocking of light guards
- The magnetic latch can be easily fitted in any actuating plane

101096092 - AZ 15/16-B3-1747

- For very small actuating radii at 90° to the plane of the actuator
- Suitable for retrofitting
- For play-free interlocking of light guards



101137434 - AZ 15/16-B6

- For very small actuating radii in line with or at 90° to the plane of the actuator



Door-handle system



AZ 16-STS30

- Latching handle
- Suitable for all types of guard

Accessories

101149214 - Mounting set MS AZ 15/16 R/P

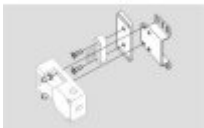

101150373 - Mounting set MS AZ 15/16 P

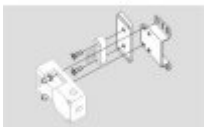

101089116 - Slot sealing plugs AZ 15/16-1476

- For protection against the ingress of coarse dirt
- To cover unused actuator slots
- Simple clip-in fitting



101115025 - Ball latch 2053-2

- Additional ball latch for stable latching of light to medium-weight guards
- For separate mounting on the guard



101110500 - SZ 16/335

- To prevent inadvertent closing, e.g. during maintenance
- For complex plant
- Prevents actuation of the switch



- Up to 6 padlocks can be fitted
 - The lockout tag can be mounted on a chain near to the safety switch
-

Mounting accessories



1135338 - TAMPERPROOF SCREWS M 5 x 12

- To mount the actuator
 - Higher protection against tampering with interlock
 - Protects against unauthorised removal of actuator
 - Various lengths available
-



101135339 - TAMPERPROOF SCREWS M 5 x 16

- To mount the actuator
 - Higher protection against tampering with interlock
 - Protects against unauthorised removal of actuator
 - Various lengths available
-



101135340 - TAMPERPROOF SCREWS M 5 x 20

- To mount the actuator
 - Higher protection against tampering with interlock
 - Protects against unauthorised removal of actuator
 - Various lengths available
-

K.A. Schmersal GmbH & Co. KG, Möddinghofe 30, D-42279 Wuppertal

The data and values have been checked thoroughly. Technical modifications and errors excepted.

Generiert am 01.02.2016 - 22:44:12h Kasbase 3.2.1.F.64l