

## Datasheet - AZ 16-02ZVRK

Safety switch with separate actuator / AZ 16



Preferred typ



(Minor differences between the printed image and the original product may exist!)

- Thermoplastic enclosure
- Double-insulated
- Large wiring compartment
- 52 mm x 90 mm x 30 mm
- Multiple coding
- Long life
- High level of contact reliability with low voltages and currents
- Insensitive to soiling
- Slotted holes for adjustment, circular holes for location
- 3 cable entries M 16 x 1.5

### Ordering details

Product type description	AZ 16-02ZVRK
Article number	101147145
EAN code	4030661141671
eCl@ss	27-27-26-02

### Approval

Approval

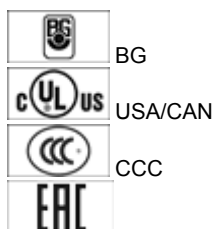

### Classification

Standards	EN ISO 13849-1
B <sub>10d</sub> Opener (NC)	2.000.000
Mission time	20 Years
notice	$MTTF_d = \frac{B_{10d}}{0,1 \times n_{op}}$ $n_{op} = \frac{d_{op} \times h_{op} \times 3600 \text{ s/h}}{t_{cycle}}$

### Global Properties

Product name	AZ 16
Standards	EN 60947-5-1, BG-GS-ET-15
Compliance with the Directives (Y/N) 	Yes
Materials	
- Material of the housings	Plastic, glass-fibre reinforced thermoplastic, self-extinguishing
- Material of the contacts	Silver
Housing coating	None
Weight	115 g

## Mechanical data

---

Design of electrical connection	Screw connection
Cable section	
- Min. Cable section	0,75 mm <sup>2</sup>
- Max. Cable section	2.5 mm <sup>2</sup>
Mechanical life	> 1.000.000 operations
notice	All indications about the cable section are including the conductor ferrules.
higher Latching force (Y/N)	Yes
Latching force	30 N
With ejection force (Y/N)	No
Positive break force	20 N
positive break travel	8 mm
Actuating speed	max. 2 m/s

## Ambient conditions

---

Ambient temperature	
- Min. environmental temperature	-30 °C
- Max. environmental temperature	+80 °C
Protection class	IP67 to IEC/EN 60529

## Electrical data

---

Design of control element	Opener (NC)
Switching principle	Creep circuit element
Number of auxiliary contacts	0 piece
Number of safety contacts	2 piece
Rated impulse withstand voltage U <sub>imp</sub>	6 kV
Rated insulation voltage U <sub>i</sub>	500 V
Thermal test current I <sub>the</sub>	10 A
Utilisation category	AC-15: 230 V / 4 A, DC-13: 24 V / 4 A
Max. fuse rating	6 A gG D-fuse

## ATEX

---

Explosion protection categories for gases	None
Explosion protected category for dusts	None

## Dimensions

---

Dimensions of the sensor	
- Width of sensor	52 mm
- Height of sensor	90 mm

- Length of sensor

30 mm

### Included in delivery

Actuators must be ordered separately.

### Diagram

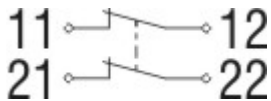

Note Diagram

- positive break NC contact
- active
- no active
- Normally-open contact
- Normally-closed contact

### Switch travel diagram

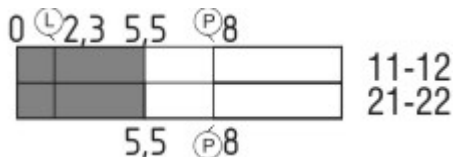

Notes Switch travel diagram

- Contact closed
- Contact open
- Setting range
- Break point
- Positive opening sequence/- angle
- VS** adjustable range of NO contact
- VÖ** adjustable range of NC contact
- N** after travel

### Ordering suffix

The applicable ordering suffix is added at the end of the part number of the safety switch.

Order example: AZ 16-02ZVRK-**2254**

...-**2254** Latching force 5 N

...-**M20** cable entries M20

### Ordering code

AZ 16-(1)ZV(2)K-(3)-(4)-(5)

- (1) without 1 Normally open contact (NO) / 1 Opener (NC)
- 02 2 Opener (NC)
- 03 3 Opener (NC)

12	Normally open contact (NO) 1 / Opener (NC) 2
(2)	
without	Ejection force
R	Latching force 30 N
(3)	
G24	with LED ( <i>only available for version with one NO and one NC contact.</i> )
(4)	
without	Cable entry M16
M20	Cable entry M20
ST	Connector M12, 4-pole, bottom
STL	Connector M12, 4-pole, left
STR	Connector M12, 4-pole, right
(5)	
2254	Latching force 5 N
1762	Front mounting
1637	gold-plated contacts

## Documents

---

**Operating instructions and Declaration of conformity** (pt) 433 kB, 25.05.2010

Code: mrl\_az15-16\_pt

**Operating instructions and Declaration of conformity** (pt) 268 kB, 21.08.2013

Code: mrl\_az15-16\_pt

**Operating instructions and Declaration of conformity** (de) 265 kB, 05.10.2015

Code: mrl\_az15-16\_de

**Operating instructions and Declaration of conformity** (fr) 268 kB, 29.07.2013

Code: mrl\_az15-16\_fr

**Operating instructions and Declaration of conformity** (jp) 374 kB, 10.07.2013

Code: mrl\_az15-16\_jp

**Operating instructions and Declaration of conformity** (cs) 400 kB, 11.10.2011

Code: mrl\_az15-16\_cs

**Operating instructions and Declaration of conformity** (es) 282 kB, 24.11.2015

Code: mrl\_az15-16\_es

**Operating instructions and Declaration of conformity** (pl) 313 kB, 06.02.2015

Code: mrl\_az15-16\_pl

**Operating instructions and Declaration of conformity** (sv) 275 kB, 17.06.2015

Code: mrl\_az15-16\_sv

**Operating instructions and Declaration of conformity** (da) 398 kB, 17.11.2011

Code: mrl\_az15-16\_da

**Operating instructions and Declaration of conformity** (en) 280 kB, 05.10.2015

Code: mrl\_az15-16\_en

**Operating instructions and Declaration of conformity** (ro) 400 kB, 18.11.2011

Code: mrl\_az15-16\_ro

**Operating instructions and Declaration of conformity** (nl) 266 kB, 02.07.2013

Code: mrl\_az15-16\_nl

**Operating instructions and Declaration of conformity** (fi) 256 kB, 02.07.2015

Code: mrl\_az15-16\_fi

**Operating instructions and Declaration of conformity** (it) 276 kB, 04.11.2015

Code: mrl\_az15-16\_it

**Mounting and wiring instructions** (de, en, fr, it, es, jp) 181 kB, 12.06.2007

Code: m\_mazp01

**BG-test certificate** (en) 135 kB, 18.11.2014

Code: z\_z15p02

**BG-test certificate** (de) 138 kB, 18.11.2014

Code: z\_z15p01

**CCC certification** (cn) 270 kB, 20.01.2016

Code: q\_175p03

**CCC certification** (en) 316 kB, 20.01.2016

Code: q\_175p02

**EAC certification** (ru) 844 kB, 05.10.2015

Code: q\_6037p17\_ru

## Images

---

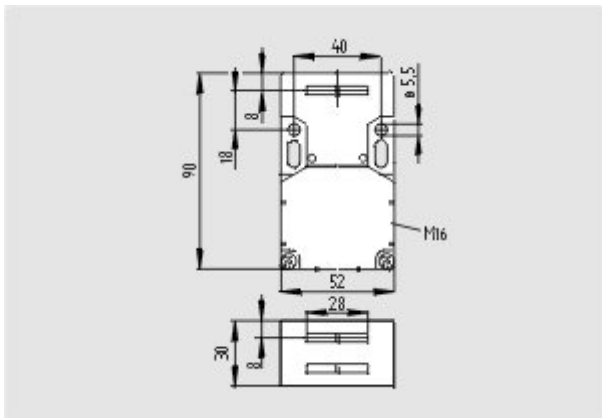

Dimensional drawing (basic component)

---

## System components

---

### Actuator

101083036 - AZ 15/16-B1





**101092711 - AZ 15/16-B1-1747**

- For play-free interlocking of light guards
- Suitable for retrofitting



**101093553 - AZ 15/16-B1-1747**

- For play-free interlocking of light guards
- The magnetic latch can be easily fitted in any actuating plane
- Suitable for retrofitting



**101108276 - AZ 15/16-B1-2024**



**101108278 - AZ 15/16-B1-2024 WITH SLOT SEALING PLUG**

- For protection against the ingress of course dirt



**101111079 - AZ 15/16-B1-2053**

- For interlocking of light to medium-weight guards



**101111081 - AZ 15/16-B1-2053 WITH BALL LATCH**

- For interlocking of light to medium-weight guards



**101126793 - AZ 15/16-B1-2177**

- For interlocking of light, unguided guards

---

**101126794 - AZ 15/16-B1-2177 WITH CENTERING GUIDE**

- For interlocking of light, unguided guards



---

**101137408 - AZ 15/16-B1-2245**

- Damps vibration on guard device

---

**101095558 - AZ 15/16-B2**

- For very small actuating radii in line with the plane of the actuator

---

**101096091 - AZ 15/16-B2-1747**

- For very small actuating radii in line with the plane of the actuator
- Suitable for retrofitting
- For play-free interlocking of light guards

---

**101096089 - AZ 15/16-B2-1747 WITH MAGNETIC LATCH**

- For very small actuating radii in line with the plane of the actuator
- Suitable for retrofitting
- For play-free interlocking of light guards
- The magnetic latch can be easily fitted in any actuating plane

---

**101095550 - AZ 15/16-B3**

- For very small actuating radii at 90° to the plane of the actuator

---

**101096090 - AZ 15/16-B3-1747 WITH MAGNETIC LATCH**

- For very small actuating radii at 90° to the plane of the actuator
- Suitable for retrofitting
- For play-free interlocking of light guards
- The magnetic latch can be easily fitted in any actuating plane

---

**101096092 - AZ 15/16-B3-1747**

- For very small actuating radii at 90° to the plane of the actuator
- Suitable for retrofitting
- For play-free interlocking of light guards



**101137434 - AZ 15/16-B6**

- For very small actuating radii in line with or at 90° to the plane of the actuator

---

**Door-handle system**



**AZ 16-ST530**

- Latching handle
- Suitable for all types of guard

---

**Accessories**

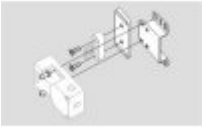

**101149214 - Mounting set MS AZ 15/16 R/P**

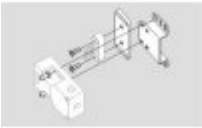

**101150373 - Mounting set MS AZ 15/16 P**



**101089116 - Slot sealing plugs AZ 15/16-1476**

- For protection against the ingress of coarse dirt
- To cover unused actuator slots
- Simple clip-in fitting



**101115025 - Ball latch 2053-2**

- Additional ball latch for stable latching of light to medium-weight guards
- For separate mounting on the guard



**101110500 - SZ 16/335**

- To prevent inadvertent closing, e.g. during maintenance
- For complex plant
- Prevents actuation of the switch
- Up to 6 padlocks can be fitted
- The lockout tag can be mounted on a chain near to the safety switch

---

**Mounting accessories**

**1135338 - TAMPERPROOF SCREWS**





#### **M 5 x 12**

- To mount the actuator
  - Higher protection against tampering with interlock
  - Protects against unauthorised removal of actuator
  - Various lengths available
- 



#### **101135339 - TAMPERPROOF SCREWS M 5 x 16**

- To mount the actuator
  - Higher protection against tampering with interlock
  - Protects against unauthorised removal of actuator
  - Various lengths available
- 



#### **101135340 - TAMPERPROOF SCREWS M 5 x 20**

- To mount the actuator
  - Higher protection against tampering with interlock
  - Protects against unauthorised removal of actuator
  - Various lengths available
- 

K.A. Schmersal GmbH & Co. KG, Möddinghofe 30, D-42279 Wuppertal

The data and values have been checked thoroughly. Technical modifications and errors excepted.

Generiert am 01.02.2016 - 03:41:33h Kasbase 3.2.1.F.64I