

Instruction Manual

MM1000

ENGLISH

- BACKLIGHT
- BAR GRAPH
- LEAD HOLDER
- MAX/MIN
- 3-3/4 DIGIT 3999 COUNT LCD
- DATA HOLD
- AUTO/MANUAL RANGE

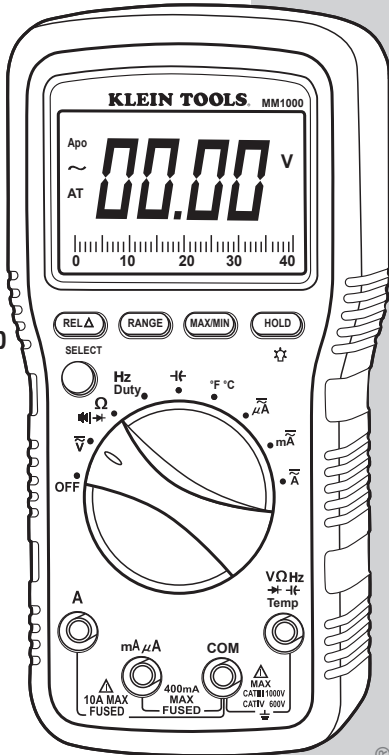

KLEIN TOOLS®

www.kleintools.com

For Professionals... Since 1857®

ENGLISH

MM1000 Instruction Manual

GENERAL SPECIFICATIONS

The Klein Tools MM1000 is an auto-ranging multimeter. It measures AC/DC voltage, AC/DC current, resistance, capacitance, frequency, duty cycle, and temperature. It can also test diodes and continuity.

- **Operating Altitude:** 2000m
- **Relative Humidity:** < 75%
- **Operating Temperature:** 0°C / 32°F to 40°C / 104°F
- **Storage Temperature:** -20°C / -4°F to 60°C / 140°F < 80% R.H.
- **Accuracy Temperature:** 18°C / 64°F to 28°C / 82°F
- **Temperature Coefficient:** 0.1* (specified accuracy) / °C
- **Sampling Frequency:** 3 samples per second
- **Dimensions:** 7" x 3.5" x 1.875"
- **Weight:** 14oz.
- **Calibration:** Accurate for one year
- **CAT Rating:** CAT III 1000V, CAT IV 600V
- **Accuracy:** ±(% of reading + # of least significant digits)

⚠ WARNINGS

To ensure safe operation and service of the tester, follow these instructions. Failure to observe these warnings can result in severe injury or death.

- Before each use, verify meter operation by measuring a known voltage or current.
- Never use the meter on a circuit with voltages that exceed the category based rating of this meter.
- Do not use the meter during electrical storms, or in wet weather.
- Do not use the meter or test leads if they appear to be damaged.
- Ensure meter leads are fully seated, and keep fingers away from the metal probe contacts when making measurements.
- Do not open the meter to replace batteries while the probes are connected.
- Use caution when working with voltages above 60V DC, or 25V AC RMS. Such voltages pose a shock hazard.
- To avoid false readings that can lead to electrical shock, replace batteries if a low battery indicator appears.
- Unless measuring voltage or current, shut off and lock out power before measuring resistance or capacitance.
- Always adhere to local and national safety codes. Use individual protective equipment to prevent shock and arc blast injury where hazardous live conductors are exposed.

SYMBOLS

~	AC Alternating Current	⚠	Warning or Caution
—	DC Direct Current	□	Double Insulated Class II
~	DC/AC Voltage or Current	⊖	AC Source
⊖	Ground		

FEATURE DETAILS

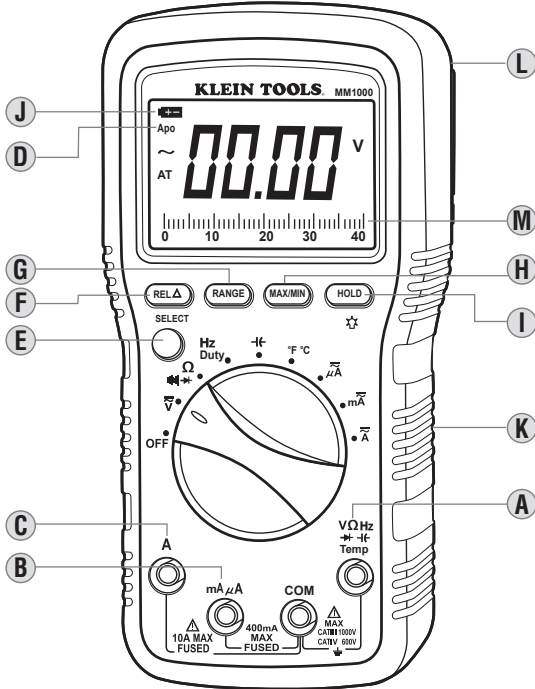

FEATURE DETAILS

A. B. C. Use CAT III / CAT IV rated leads.

- A. Do not attempt to measure more than 1000V.
- B. Do not attempt to measure more than 400mA.
- C. Do not attempt to measure more than 10A.
- D. **Auto Power-Off (Apo)**
 - Device will power off after 30 minutes non-use.
 - Turn the dial or press a button to wake.
 - Disabled during Max / Min function.
 - Holding Select button while turning on disables Auto Power-Off.
- E. **Select Functionality Button**
 - Switch between AC and DC.
 - Switch between Ω , \rightarrow , and $\text{m}\Omega$.
 - Switch between Hz and %.
 - Switch between °F and °C.
- F. **Relative Reading Mode**
 - Press to store current value.
 - Display will now show the difference between the stored and live readings.
 - Press again to return to live reading.
- G. **Auto / Manual Range**
 - Press repeatedly to cycle through manual ranges.
 - Press for 2 seconds to return to auto ranging mode.
 - **AT** is displayed on LCD only during auto ranging mode.

H. Max / Min Hold

- Press to enter Max / Min mode; the largest and smallest values will be saved while in this mode.
- Press repeatedly to alternate between the maximum and minimum readings.
- Press for 2 seconds to return to live reading and clear the stored maximum and minimum values.

I. Hold / Backlight

- Press to hold the current input on the display.
- Press again to return to live reading.
- Press for 2 seconds to enable/disable lights.
- Using lights drains the battery significantly.

J. K. Battery / Fuse Replacement

- When + indicator is displayed on the LCD, batteries must be replaced.
- Remove rubber boot, back screw, and replace 2 x AAA batteries.
- This meter uses 440mA/1000V and 11A/1000V fast blow fuses.

L. Magnetic Hanger Accessory (Optional, Sold Separately)

- Slide magnetic adapter into protective rubber boot.
- Attach instrument to metal for hands-free use.

M. Bar Graph

- The bar graph shows an approximate analog representation of a measurement.
- The bar graph responds much faster than the digital display.
- The scale of the bar graph is zero to the maximum reading of the selected range.

FUNCTION INSTRUCTIONS

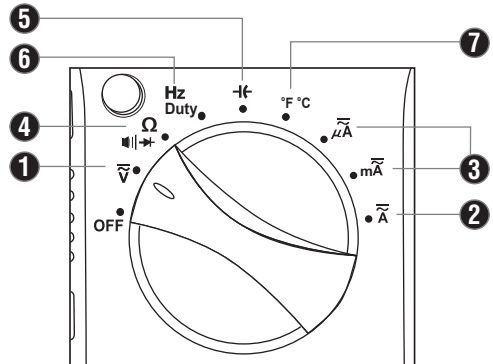

1. AC / DC Voltage: < 1000V

Features: **REL** **HOLD** **RANGE** **MAX/MIN**

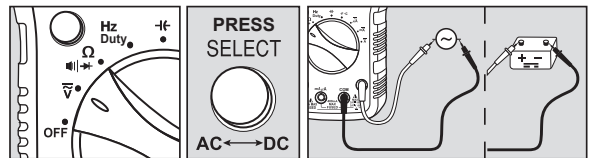

- Select AC or DC voltage source.

2. AC/DC Current (large): < 10A

Features: **REL** **HOLD** **RANGE** **MAX/MIN**

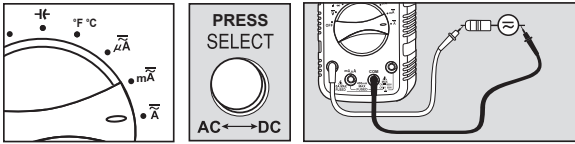

- Start with this setting if current level is unknown.
- Attach red lead to "A" input.
- Select AC or DC current source.

3. AC/DC Current (small): < 400mA

Features: **REL** **HOLD** **RANGE** **MAX/MIN**

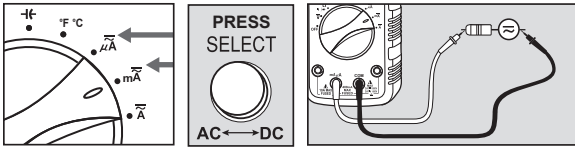

- Attach red lead to "mA μ A" input.
- Select μ A or mA, and AC or DC current source.

4. Resistance / Diode / Continuity



Resistance Features:

HOLD **RANGE** **MAX/MIN** **REL**

- **⚠** Do not measure resistance on a live circuit.
- $\Omega < 40M\Omega$

Diode Features:

HOLD **MAX/MIN**

Display shows:

- Forward voltage drop if forward biased.
- "O.L." if reverse biased.

Continuity Features:

HOLD **MAX/MIN**

Display shows: resistance

- Forward voltage drop if forward biased.
- Buzzer sounds if less than 30Ω

5. Capacitance: < 4000 μ F

Features: **HOLD**

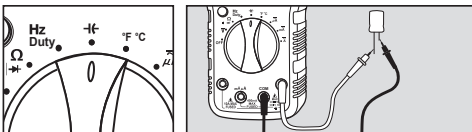

- **⚠** Safely discharge capacitor before measurement.
- Reading may take up to 60 seconds for large capacitors.

6. Frequency (Hz) / Duty Cycle < 1MHz

Features: **HOLD**

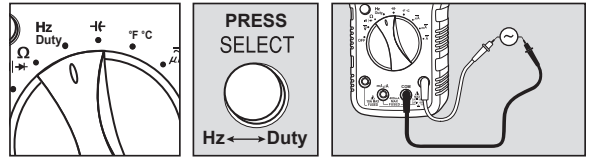

7. Temperature

Features: **HOLD** **MAX/MIN** **REL**

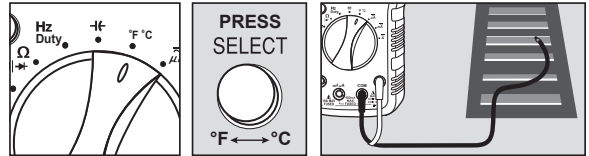

- **⚠** Do not apply voltage to thermocouple.
- Fahrenheit range: -58° to 1832° F
- Celsius range: -50° to 1000° C

Testing Fuses

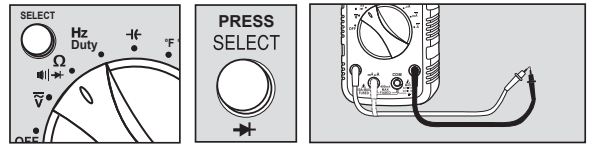

- "O.L." indicates blown fuse.

SYMBOLS USED ON LCD

~	AC Measurement	---	DC Measurement
-	Negative DC Value	AT	Auto Range Active
O.L.	Overload: Range Exceeded	Apo	Auto Power-Off Active
+	Low Battery	HOLD	Hold Active
MIN	Minimum Reading	MAX	Maximum Reading
%	Duty Cycle Mode	Hz	Frequency Mode
V	Voltage Measurement	A	Current in Amps
Ω	Resistance in Ohms	\blacktriangle	Relative Reading
F	Capacitance in Farads	$\rightarrow $	Diode Test
$^{\circ}$ F	Degrees Fahrenheit	$\ \ $	Continuity Test
n	Nano 10^{-9}	$^{\circ}$ C	Degrees Celsius
m	Milli 10^{-3}	μ	Micro 10^{-6}
M	Mega 10^6	k	Kilo 10^3

ELECTRICAL SPECIFICATIONS

DC Voltage Measurement

Range	Resolution	Accuracy
400mV - 400V	0.1mV - 0.1V	± (0.5% + 4 digits)
1000V	1V	± (0.8% + 10 digits)

Overload Protection: 1000 V Input Impedance (Nominal): > 10 MΩ, < 100 pF

AC Voltage Measurement

Range	Resolution	Accuracy
400mV - 400V	0.1mV - 0.1V	± (0.75% + 5 digits) 40Hz - 400Hz
1000V	1V	± (1.0% + 8 digits) 40Hz - 400Hz

Overload Protection: 1000V RMS Input Impedance (Nominal): > 10MΩ, < 100pF
Response: Averaging

DC Current Measurement

Range	Resolution	Accuracy
400μA - 400mA	0.1μA - 0.1mA	± (1.0% + 5 digits)
4A - 10A	1mA - 10mA	± (1.5% + 5 digits)

Overload Protection:
 • μAmA Input: 400mA (F 440mA/1000V fuse)
 • A Input: 10A (F 11A/1000V fuse)

AC Current Measurement

Range	Resolution	Accuracy
400μA - 400mA	0.1μA - 0.1mA	± (1.5% + 5 digits)
4A - 10A	1mA - 10mA	± (2.0% + 5 digits)

Overload Protection:
 • μAmA Input: 400mA (F 440mA/1000V fuse)
 • A Input: 10A (F 11A/1000V fuse)

Frequency: 40Hz to 400Hz
Response: Averaging

Resistance Measurement

Range	Resolution	Accuracy
400Ω - 4MΩ	0.1Ω - 0.001MΩ	± (1.0% + 5 digits)
40MΩ	0.01MΩ	± (1.5% + 10 digits)

Overload Protection: 600V RMS

Capacitance Measurement

Range	Resolution	Accuracy
40nF	0.01nF	± (3.5% + 6 digits)
400nF - 4000μF	0.1nF - 1μF	

Overload Protection (Voltage): 600V RMS

Frequency Measurement

Range	Resolution	Accuracy
9.999Hz - 999.9kHz	0.001Hz - 0.1kHz	± (0.1% + 3 digits)

Overload Protection: 600V RMS Sensitivity: 0.7V RMS

Duty Cycle Measurement

Range	Resolution	Accuracy
0.1 - 99.9%	0.1%	± (0.2% per kHz + 0.1% + 5 digits)

Overload Protection: 600V RMS Frequency Range: 0.5Hz to 100kHz, pulsewidth > 2μsec

Temperature Measurement

Range	Resolution	Accuracy
-58 - 1832°F	0.1 ~ 1°F	± (3.0% + 5.4°F)
-50 - 1000°C	0.1 ~ 1°C	± (3.0% + 3.0°C)

Overload Protection: 600V RMS Thermocouple Accuracy: Not specified

Diode Test

Overload Protection	Test Current (Typical)	Open Circuit Voltage	Range
600V RMS	0.25mA	< 1.6V DC	2.0V DC

Continuity Test

Overload Protection	Open Circuit Voltage
600V RMS	Appx. 0.44V

WARRANTY

This product is warranted to be free from defects in materials and workmanship for a period of two years from the date of purchase. During this warranty period, Klein Tools has the option to repair or replace or refund the purchase price of any unit which fails to conform to this warranty under normal use and service. This warranty does not cover damage which occurs in shipment or failure which results from alteration, tampering, accident, misuse, abuse, neglect, or improper maintenance. Batteries and damage resulting from failed batteries are not covered by warranty. A purchase receipt or other proof of original purchase date will be required before warranty repairs will be rendered.

Any implied warranties, including but not limited to implied warranties of merchantability and fitness for a particular purpose, are limited to the express warranty. Klein Tools shall not be liable for loss of use of the instrument or other incidental or consequential damages, expenses, or economic loss, or for any claim or claims for such damage, expenses or economic loss.

Some states or countries laws vary, so the above limitations or exclusions may not apply to you. This warranty gives you specific legal rights, and you may also have other rights which vary from state to state. If your Klein product requires repair or for information on how to exercise your rights under the terms of this warranty, please contact Klein Tools at 1-877-775-5346.

CLEANING

Turn instrument off and disconnect test leads. Clean the instrument by using a damp cloth. Do not use abrasive cleaners or solvents.

STORAGE

Remove the batteries when instrument is not in use for a prolonged period of time. Do not expose to high temperatures or humidity. After a period of storage in extreme conditions exceeding the limits mentioned in the Specifications section, allow the instrument to return to normal operating conditions before using it.

DISPOSAL / RECYCLE



Caution: This symbol indicates that equipment and its accessories shall be subject to a separate collection and correct disposal.

KLEIN TOOLS®

CUSTOMER SERVICE

KLEIN TOOLS, INC.
 450 Bond Street
 Lincolnshire, IL 60069
 1-877-775-5346
 www.kleintools.com