

# Instruction Manual

## CL1000

### ENGLISH

- DATA HOLD
- BACKLIGHT
- WORKLIGHT
- BAR GRAPH
- MAX/MIN
- 3-3/4 DIGIT  
3999 COUNT LCD
- AUTO/MANUAL RANGE
- NON CONTACT VOLTAGE TESTER

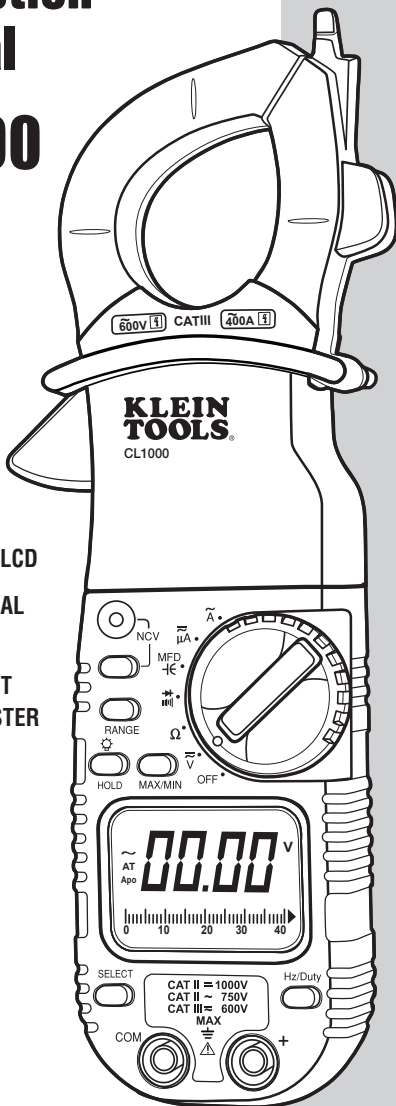

# KLEIN TOOLS®

www.kleintools.com

For Professionals... Since 1857®

### ENGLISH

## CL1000 Instruction Manual

### GENERAL SPECIFICATIONS

The Klein Tools CL1000 is an auto-ranging clamp meter. It measures AC/DC voltage, AC/DC current, resistance, capacitance, frequency, and duty cycle. It can also test non-contact voltage, diodes, and continuity.

- **Operating Altitude:** 2000 meters
- **Humidity:** 80% max
- **Operating Temperature:** 0°C/32°F to 45°C/113°F
- **Storage Temperature:** 0°C/32°F to 60°C/140°F
- **Accuracy Temperature:** 18°C/64°F to 28°C/82°F
- **Temperature Coefficient:** 0.1\* (specified accuracy)/°C
- **Dimensions:** 8.875" x 3.375" x 1.5"
- **Weight:** 10.7oz.
- **Calibration:** Accurate for one year
- **CAT Rating:** CAT III 600V
- **Accuracy:** ± (% of reading + # of least significant digits)

### ⚠ WARNINGS

To ensure safe operation and service of the tester, follow these instructions. Failure to observe these warnings can result in severe injury or death.

- Before each use, verify meter operation by measuring a known voltage or current.
- Never use the meter on a circuit with voltages that exceed the category based rating of this meter.
- Do not use the meter during electrical storms, or in wet weather.
- Do not use the meter or test leads if they appear to be damaged.
- Ensure meter leads are fully seated, and keep fingers away from the metal probe contacts when making measurements.
- Do not open the meter to replace batteries while the probes are connected.
- Use caution when working with voltages above 60V DC, or 25V AC RMS. Such voltages pose a shock hazard.
- To avoid false readings that can lead to electrical shock, replace batteries if a low battery indicator appears.
- Unless measuring voltage or current, shut off and lock out power before measuring resistance or capacitance.
- Always adhere to local and national safety codes. Use individual protective equipment to prevent shock and arc blast injury where hazardous live conductors are exposed.

### SYMBOLS

AC Alternating Current	Warning or Caution
DC Direct Current	Dangerous levels
DC/AC Voltage or Current	Double Insulated Class II
Ground	Safe for disconnect from live conductors
AC Source	

FEATURE DETAILS

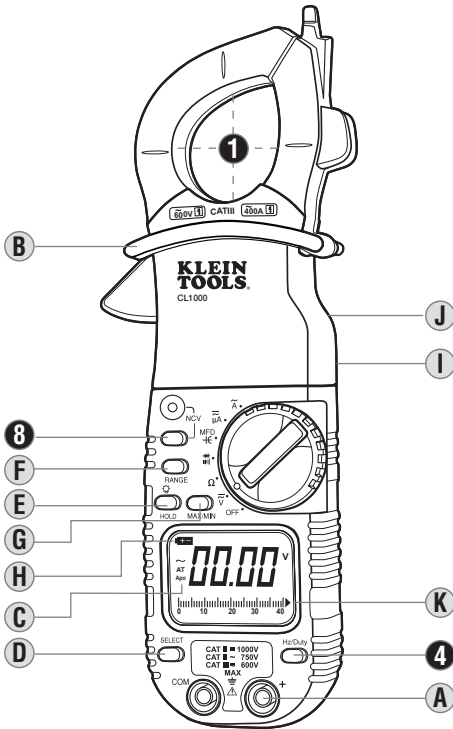

- A. Use CAT III rated leads or higher.**  
Do not attempt to measure more than 1000V DC or 750V AC or 2000 $\mu$ A.
- B. Keep hands below line when measuring high current levels.**
- C. Auto Power-Off (Apo)**
  - Device will power off after 30 minutes non-use.
  - Turn the dial or press a button to wake.
  - Disabled during Max / Min function.
  - Holding Select button while turning on disables Auto Power-Off.
- D. Select Functionality Button**
  - Switch between AC and DC.
  - Switch between  $\rightarrow$  and  $\leftarrow$ .
- E. Hold /Backlight /Worklight**
  - Press to hold the current input on the display.
  - Press again to return to live reading.
  - Press for 2 seconds to enable /disable lights.
  - Using lights drains the battery significantly.
- F. Auto /Manual Range**
  - Press repeatedly to cycle through manual ranges.
  - Press for 2 seconds to return to auto ranging mode.
  - **AT** is displayed on LCD only during auto ranging mode.
- G. Max /Min Hold**
  - Press to enter Max / Min mode; the largest and smallest values will be saved while in this mode.
  - Press repeatedly to alternate between the maximum and minimum readings.
  - Press for 2 seconds to return to live reading and clear the stored maximum and minimum values.
- H. I. Battery Replacement**
  - When  $\oplus$  indicator is displayed on the LCD, batteries must be replaced.
  - Remove the back screw and replace 2 x AAA batteries.

- J. Magnetic Back**
  - Attach instrument to metal for hands-free use.
- K. Bar Graph**
  - The bar graph shows an approximate analog representation of a measurement.
  - The bar graph responds much faster than the digital display.
  - The scale of the bar graph is zero to the maximum reading of the selected range.

FUNCTION INSTRUCTIONS

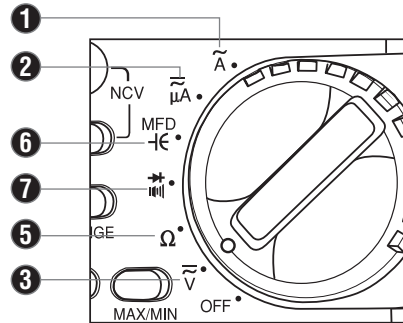

1. AC Current (large): < 400A

Features: **HOLD** **RANGE** **MAX/MIN**

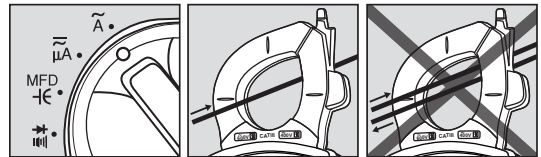

- Center wire in guides for best accuracy.
- Opposing currents cancel (*use line-splitter when necessary*).

2. AC /DC Current (small): < 2000 $\mu$ A

Features: **HOLD** **RANGE** **MAX/MIN**

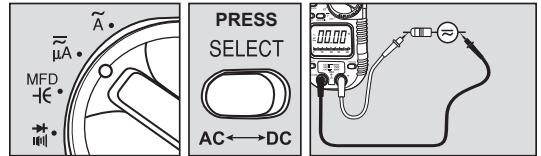

- Select AC or DC current source.
- $\Delta$  Current above 2000 $\mu$ A will damage instrument.

3. AC /DC Voltage: < 750V AC or 1000V DC

Features: **HOLD** **RANGE** **MAX/MIN**

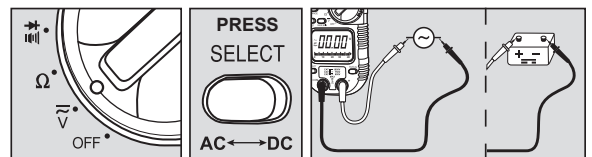

- Select AC or DC voltage source.

4. Frequency (Hz) / Duty Cycle (See Feature Details)

Features: **HOLD**

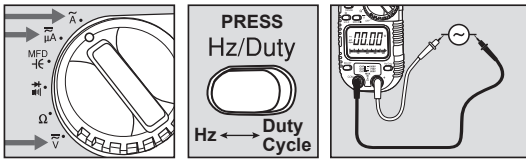

- Select  $\bar{V}$ ,  $\bar{\mu}A$ , or  $\bar{A}$  setting.
- Frequencies greater than 1MHz will display "0.000Hz".

5. Resistance: < 40M $\Omega$

Features: **HOLD** **RANGE** **MAX/MIN**

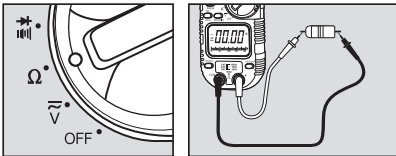

- $\blacktriangle$  Do not measure resistance on a live circuit.

6. Capacitance: < 4000 $\mu F$

Features: **HOLD**

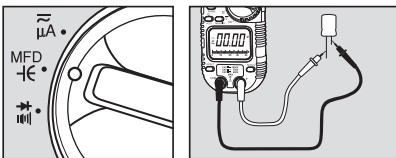

- $\blacktriangle$  Safely discharge capacitor before measurement.
- Reading may take up to 60 seconds for large capacitors.

7. Diode / Continuity

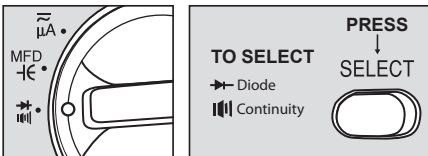

Diode Features:

**HOLD** **MAX/MIN**

Display shows:

- Forward voltage drop if forward biased.
- "O.L." if reverse biased.

Continuity Features:

**HOLD** **MAX/MIN**

- Display shows resistance.
- Buzzer sounds if less than 30 $\Omega$ .

8. Non Contact Voltage (NCV): > 25V AC

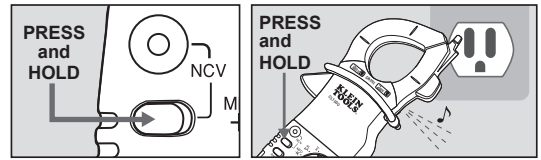

SYMBOLS USED ON LCD

$\sim$	AC Measurement	$\equiv$	DC Measurement
$-$	Negative DC Value	<b>AT</b>	Auto Range Active
<b>O.L.</b>	Overload: Range Exceeded	<b>Apo</b>	Auto Power-Off Active
<b>+ -</b>	Low Battery	<b>HOLD</b>	Hold Active
<b>MIN</b>	Minimum Reading	<b>MAX</b>	Maximum Reading
<b>%</b>	Duty Cycle Mode	<b>Hz</b>	Frequency Mode
<b>V</b>	Voltage Measurement	<b>A</b>	Current in Amps
$\Omega$	Resistance in Ohms	$\blacktriangleright$	Diode Test
<b>F</b>	Capacitance in Farads	$\parallel$	Continuity Test
<b>n</b>	Nano 10 <sup>-9</sup>	$\mu$	Micro 10 <sup>-6</sup>
<b>m</b>	Milli 10 <sup>-3</sup>	<b>k</b>	Kilo 10 <sup>3</sup>
<b>M</b>	Mega 10 <sup>6</sup>		

ELECTRICAL SPECIFICATIONS

DC Voltage Measurement

Range	Resolution	Accuracy
400mV ~ 400V	0.1mV ~ 0.1V	$\pm$ (0.5% + 4 digits)
1000V	1V	$\pm$ (0.8% + 10 digits)

Overload Protection: 1000V

AC Voltage Measurement

Range	Resolution	Accuracy
400mV ~ 750V	0.1mV ~ 1V	$\pm$ (2.0% + 5 digits)

Overload Protection: 750V RMS

Frequency Response: 40 to 400 Hz

Minimum Voltage for Frequency Measurement: 200mV

Response: Averaging

DC Current Measurement

Range	Resolution	Accuracy
400 $\mu A$	0.1 $\mu A$	$\pm$ (1.2% + 3 digits)
2000 $\mu A$	1 $\mu A$	

Overload Protection:

- Voltage: 600V RMS
- Current: 2000 $\mu A$

**AC Current Measurement**

Range	Resolution	Accuracy
400µA	0.1µA	± (2.0% + 5 digits)
2000µA	1µA	± (1.5% + 5 digits)
40A	0.01A	± (2.9% + 15 digits)
400A	0.1A	± (1.9% + 8 digits)

**Overload Protection:**

- Voltage: 600V RMS
- Current: 2000µA

**Frequency:** 45 to 400Hz

**Minimum Current for Frequency Measurement:** 400µA or 20A

**Response:** Averaging

**Resistance Measurement**

Range	Resolution	Accuracy
400Ω - 4MΩ	0.1Ω - 0.001MΩ	± (1.0% + 4 digits)
40MΩ	0.01MΩ	± (2.0% + 4 digits)

**Overload Protection:** 600V RMS

**Capacitance Measurement**

Range	Resolution	Accuracy
40nF - 4000µF	0.01nF - 1µF	± (3.5% + 6 digits)

**Overload Protection:** 600V RMS

**Frequency Measurement**

Range	Resolution	Accuracy
9.999Hz - 999.9kHz	0.001Hz - 0.1kHz	± (0.1% + 4 digits)

**Overload Protection:** 600V RMS

**Duty Cycle Measurement**

Range	Resolution	Accuracy
0.1 - 99.9%	0.1%	± (0.2% per kHz + 0.1% + 5 digits)

**Overload Protection:** 600V RMS

**Diode Test**

Overload Protection	Range	Test Current	Open Circuit Voltage
600V RMS	2.0V	Appx. 0.25mA	< 1.6V DC

**Continuity Test**

Overload Protection	Open Circuit Voltage
600V RMS	< 0.44V

**Non Contact Voltage Detector**

On Voltage
Appx. 25V AC

**WARRANTY**

This product is warranted to be free from defects in materials and workmanship for a period of two years from the date of purchase. During this warranty period, Klein Tools has the option to repair or replace or refund the purchase price of any unit which fails to conform to this warranty under normal use and service. This warranty does not cover damage which occurs in shipment or failure which results from alteration, tampering, accident, misuse, abuse, neglect, or improper maintenance. Batteries and damage resulting from failed batteries are not covered by warranty. A purchase receipt or other proof of original purchase date will be required before warranty repairs will be rendered.

Any implied warranties, including but not limited to implied warranties of merchantability and fitness for a particular purpose, are limited to the express warranty. Klein Tools shall not be liable for loss of use of the instrument or other incidental or consequential damages, expenses, or economic loss, or for any claim or claims for such damage, expenses or economic loss.

Some states or countries laws vary, so the above limitations or exclusions may not apply to you. This warranty gives you specific legal rights, and you may also have other rights which vary from state to state. If your Klein product requires repair or for information on how to exercise your rights under the terms of this warranty, please contact Klein Tools at 1-877-775-5346.

**CLEANING**

Turn instrument off and disconnect test leads. Clean the instrument by using a damp cloth. Do not use abrasive cleaners or solvents.

**STORAGE**

Remove the batteries when instrument is not in use for a prolonged period of time. Do not expose to high temperatures or humidity. After a period of storage in extreme conditions exceeding the limits mentioned in the Specifications section, allow the instrument to return to normal operating conditions before using it.

**DISPOSAL / RECYCLE**



**Caution:** This symbol indicates that equipment and its accessories shall be subject to a separate collection and correct disposal.

**CUSTOMER SERVICE**

**KLEIN TOOLS, INC.**  
 450 Bond Street  
 Lincolnshire, IL 60069  
**1-877-283-6808**  
**www.kleintools.com**